

**Signal generator circuit
HX0074 demo kit for
DOX2xxx and DOX2xxxB**

**Demonstration GX1025 with
DOX2xxx and DOX2xxxB**

CONTENTS

GENERAL DESCRIPTION	3
PRESENTATION OF THE HX0074	3
I. TEST SIGNAL HX0074	4
1. MISCELLANEOUS	4
2. HYSTERESIS	5
3. PULSE TRAIN	7
4. DATA + CS TRAIN	8
5. DATA FRAME-FAULT	10
6. AMPLITUDE-MODULATED SINE WAVE	12
7. SQUARE WAVE-RISE TIME	13
8. SQUARE WAVE - LOW LEVEL - NOISY	14
9. COMB OF RAPID PULSES	15
10. DIGITAL FRAME + FAULT	16
11. FRAME + RARE PULSE	17
12. RECORDER-5 SIGNALS	18
13. HEART RECORDER	20
14. HARMONICS	21
15. DISTORTION	22
II. DEMONSTRATION GX1025 WITH DOX2000	23
1. USING THE GX1025 GENERATOR TO DEMONSTRATE THE ADVANTAGES OF THE "LONGMEM" MEMORY DEPTH AND OF THE DIGITAL FILTERS	23
1.1. Influence of memory depth (LongMem or Normal) on the sampling interval:	23
2. USING THE DIGITAL FILTERS	24
2.1. 2 kHz square wave with a 62 kHz sine wave superposed on its plateaus	24
3. SUM OF 2 SINUSOIDAL SIGNALS HAVING FREQUENCIES OF 10 KHZ AND 80 KHZ	26
3.1. Display of the sum of 10 kHz and 80 kHz sine waves	26
4. PRODUCT OF 2 SINE WAVES HAVING FREQUENCIES OF 100 KHZ AND 800 KHZ	28
4.1. Display of the product signal with Delayed time base	28
5. PRODUCT OF 2 SINUSOIDAL SIGNALS HAVING FREQUENCIES OF 10 KHZ AND 80 KHZ	30
5.1. Display of the product signal with Delayed time base	30

GENERAL DESCRIPTION

- The **HX0074** is an accessory with a circuit that generates 15 representative signals. It is associated with a guide describing the nature of the signals.
- The **HX0074** demonstrator makes mastering the oscilloscope faster, because the display, analysis, and measurement of the signals generated by the HX0074 make use of all functions of the DOX2000.
- We will also use a **GX1025** arbitrary generator to generate the signals specific to demonstrating the advantages of «LongMem» long recording memory depths and of using digital filters to observe composite signals.

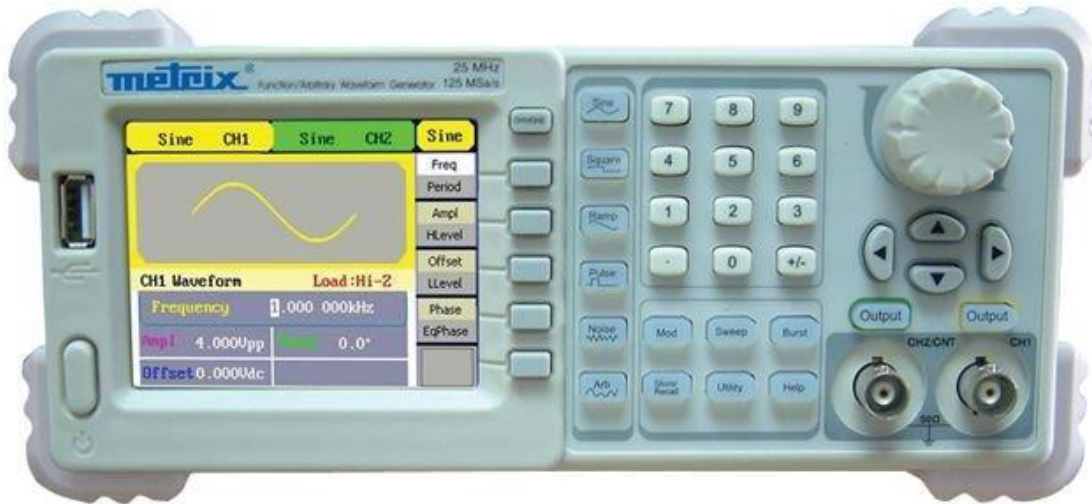

PRESENTATION OF THE HX0074

- The **HX0074** is built around a microprocessor. An LCD display unit and «UP/DOWN» buttons are used to select the desired signal. The HX0074 generates the signals on the «MAIN» and «AUX» BNCs.
- The HX0074 can be powered:
 - either by a standard 9 V battery
 - or by a 12 VDC, 200 mA external mains adapter, with positive polarity, that of METRIX MTX Mobile multimeters, for example.

The power supply mode is selected using the switch.

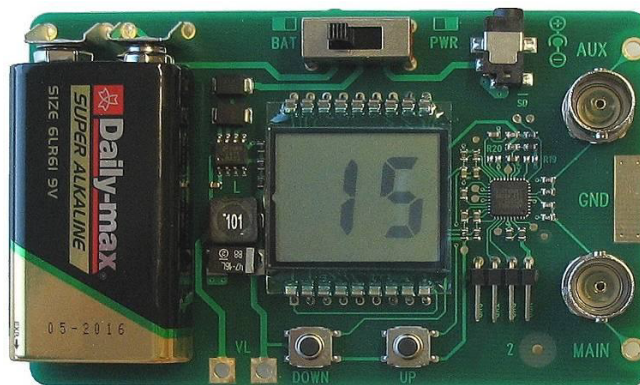

I. TEST SIGNAL HX0074

1. MISCELLANEOUS

Demo:	with:	<input checked="" type="checkbox"/> DOX2025	<input checked="" type="checkbox"/> DOX2040	<input checked="" type="checkbox"/> DOX2100	<input checked="" type="checkbox"/> DOX2xxxB
Test signal	n°1 : Miscellaneous				
Nature	4 pairs of successive signals approx. every 2 seconds.				
Specs	$2.6\text{ V} < V_{pp} < 3.2\text{ V} - 10\text{ Hz} < F < 60\text{ Hz}$				
Oscilloscope Settings	50 ms/div. - MAIN = CH1 = 1 V/div. - AUX = CH2 = 1 V/div.				
Trigger	standard on CH1 = MAIN				
Modes	XY (Display menu)				
Objective	Start in a playful manner by describing the different display modes: Normal, Delayed, XY				

a) Adjust the oscilloscope so as to display the signals correctly (possible using the «Autoset» key).

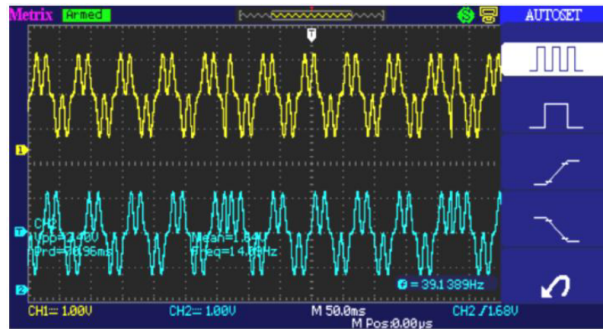

When Autoset is exited, the oscilloscope adjusts the vertical position so that the traces are not superposed.

b) Apply the "Delayed" and "ON" "OFF" commands in succession to be able to observe a complete trace and zoom on detail.

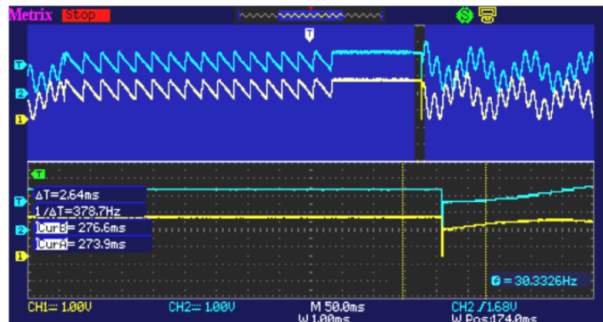

c) Select the «XY mode» with CH1 on X and CH2 on Y. Observe that there is a succession of 4 geometrical shapes.

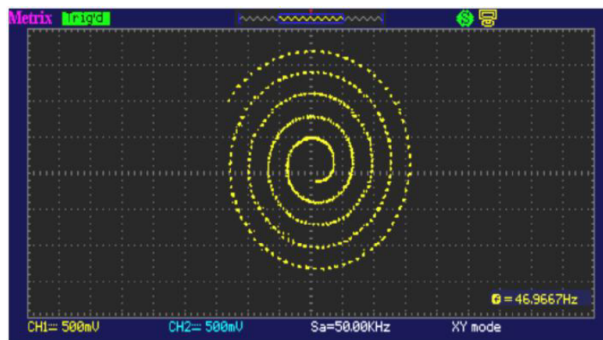

The geometrical shape obtained in XY depends on the sampling rate, which in our example is $F_{\text{sample}} = 50\text{ kHz}$.

2. HYSTERESIS

Demo:	with:	<input checked="" type="checkbox"/> DOX2025	<input checked="" type="checkbox"/> DOX2040	<input checked="" type="checkbox"/> DOX2100	<input checked="" type="checkbox"/> DOX2xxxB
Test Signal	n°2 : Hysteresis				
Nature	2 phase-shifted signals, triangle and pseudo-square				
Specs	$V_{pp} \approx 3.2 \text{ V}$ - $F \approx 1.7 \text{ kHz}$ - square wave $\approx 24 \mu\text{s}$ - signal delay $\approx 40 \mu\text{s}$				
Oscilloscope Settings	100 $\mu\text{s}/\text{div}$. - CH1 = MAIN = 500 mV/div. - CH2 = AUX = 500 mV/div.				
Trigger	standard on MAIN				
Modes	XY (Display menu) - no «Min/Max», and no «Repetitive Signal» (Horizontal menu)				
Objectives	«y(t)» and «XY» modes from phase-shifted signals Present automatic measurements with markers (F, square-wave Tr) Present phase measurements (manual, automatic) Present the FFT Mathematical function				

a) Adjust the oscilloscope so as to display the signals correctly (possible using the «Autoset» key) and select automatic phase measurement to determine the phase difference between the signals Main = CH1 and Aux = CH2.

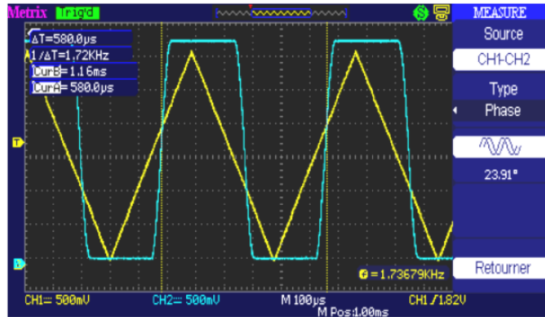

b) Select the XY mode with CH1 on X and CH2 on Y.

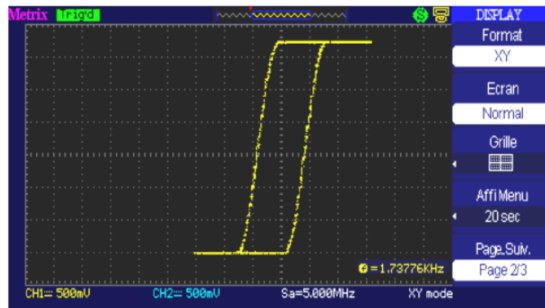

The display of a hysteresis cycle is a “textbook case” often encountered in the educational context. It demonstrates the utility of display in the y(t) and XY mode(s), respectively.

Stress the simplicity of access to the XY mode, and of access to automatic phase measurement.

c) Return to «y(t) mode» in order to demonstrate the use of the automatic measurements. (Ex.: Vpp, Vamp, Feq, Rise, ...).

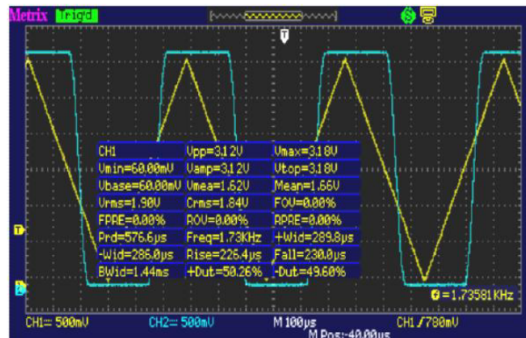

d) Use of the FFT Mathematical function.

The oscilloscope displays the CH1 signal and its FFT simultaneous. The "Time" cursors can be used to determine the frequencies of the fundamental and of the harmonics:

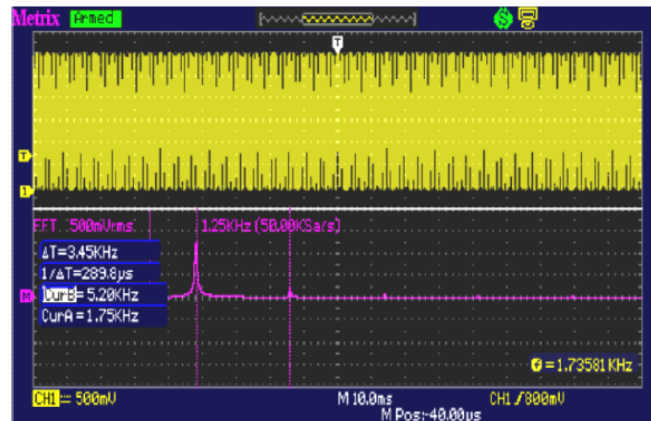

The "Voltage" cursors can be used to determine the amplitude of the harmonics:

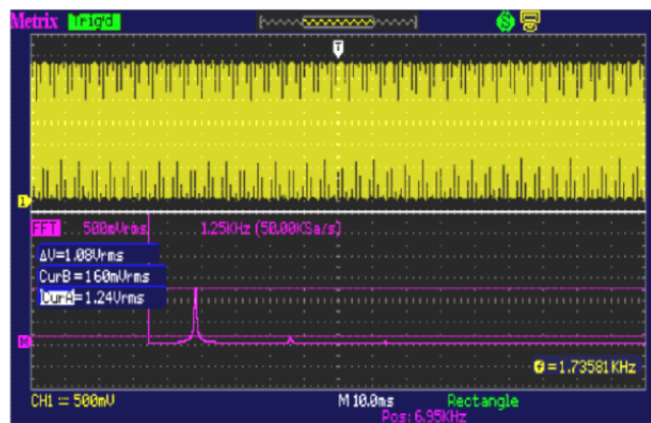

FFT of the signal on channel CH2 :

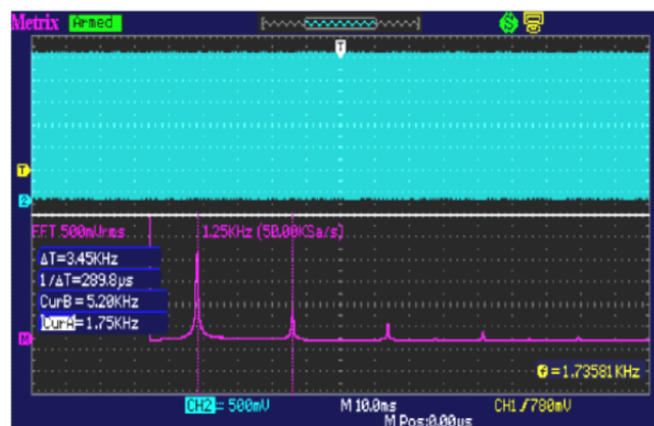

3. PULSE TRAIN

Demo:	with:	<input checked="" type="checkbox"/> DOX2025	<input checked="" type="checkbox"/> DOX2040	<input checked="" type="checkbox"/> DOX2100	<input checked="" type="checkbox"/> DOX2xxxB
Test Signal	n°3 : Pulse train				
Nature	1 signal containing trains of 10 pulses with variable spacing				
Specs	Vpp ≈ 3.4 V - F ≈ 32 kHz - Train spacings ≈ 100 to 180 μs				
Oscilloscope Settings	100 μs/div. - CH1 = MAIN = 500 mV/div				
Trigger	on CH1 = MAIN - Hold-Off ≈ 354 μs				
Modes	Triggered mode preferable				
Objective	Triggering with «Hold-Off» on pulse trains				

a) Adjust the oscilloscope to display the signal on CH1 correctly (time base, sensitivity, and triggering source).



Attention, with this type of signal, “Autoset” operation may be aleatory.

Without “Hold-Off”, the triggering may act on any pulse of the train, as soon as the oscilloscope is ready to acquire. This is accompanied by a feeling of “horizontal instability”, making the display unusable. The proper setting of the “Hold-Off” parameter (in the “Triggering” menu → “Set”) serves to ensure systematic triggering on the first pulse of the train.

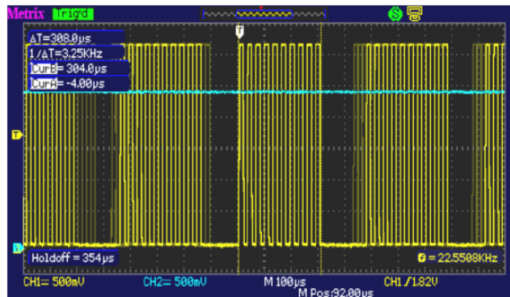

This value must be greater than the duration of the pulse train, to disable triggering during this period, but must remain shorter than the time between 2 pulse trains (which varies between 400 and 480 μs). In our case, the “Hold-Off” must be between 300 and 400 μs.

b) Definition of the mask of the “Pass/Fail” function. “Utility” → Pass/Fail → Mask Config → Mask Generation

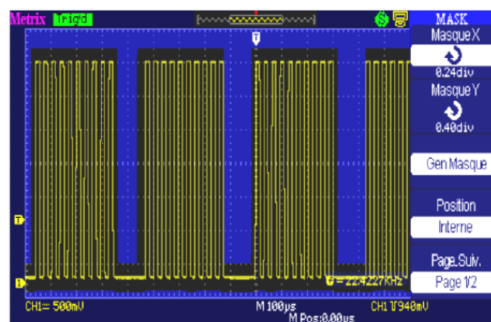

c) Activation of the Pass/Fail function

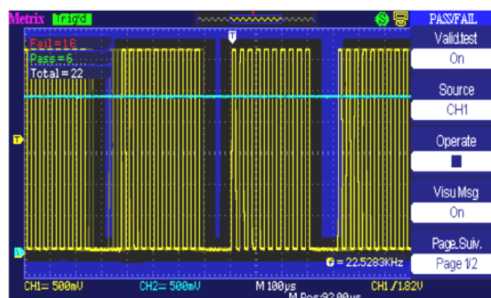

The Pass/Fail function displays the number of times that the signal has satisfied (“Pass”) or not satisfied (“Fail”) the mask defined.

4. DATA + CS TRAIN

Demo:	with:	<input checked="" type="checkbox"/> DOX2025	<input checked="" type="checkbox"/> DOX2040	<input checked="" type="checkbox"/> DOX2100	<input checked="" type="checkbox"/> DOX2xxxB
Test Signal	n°4 : Data + CS train				
Nature	2 signals representing a digital frame (data) and a CS (chip select)				
Specs	Vpp ≈ 3.4 V - F ≈ 40 kHz (data) - F ≈ 1.5 kHz (CS)				
Oscilloscope Settings	100 μs/div. - MAIN = 1 V/div. - AUX ≈ 1 V/div.				
Trigger	on BNC AUX = CH2				
Modes	Triggered mode preferable				
Objective	Triggering on pulses				

a) Adjust the oscilloscope to display simply the 2 signals (time base, sensitivities and triggering source on the BNC AUX = CH2).



Attention, with this type of signal, “Autoset” operation may be aleatory.

b) We are now going to demonstrate the utility of the pulse width triggers. The example chosen will serve to synchronize to the chip select signal of the data frame. We are going to trigger by turns on the width of the high level, then of the low level, of the “positive” pulse. In the first case, triggering will be on the negative-going edge of the chip select and in the second case it will be on the positive-going edge.

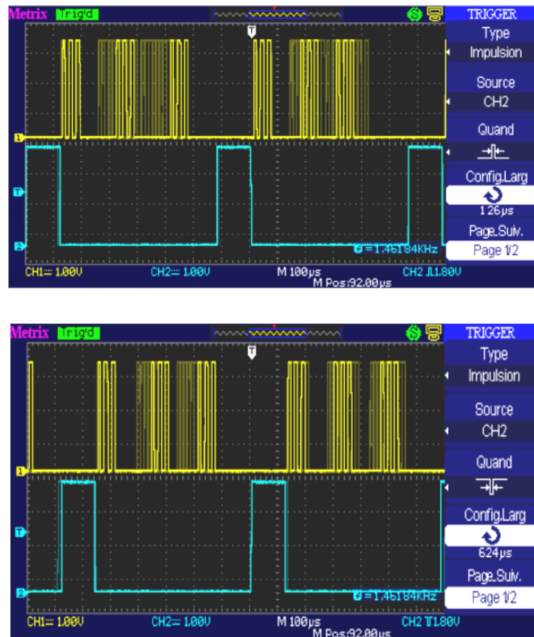

c) Observe the first data group after the negative-going edge of the chip select using the “**Delayed**” function.

Example: to display the 2nd group of pulses, we shift the window by acting on the horizontal position.

Expansion by 25

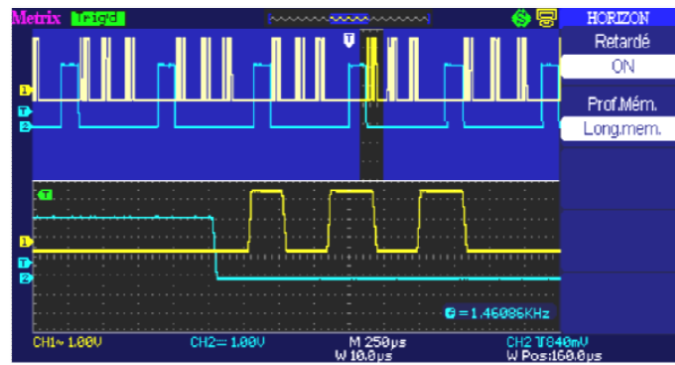

Expansion by 100

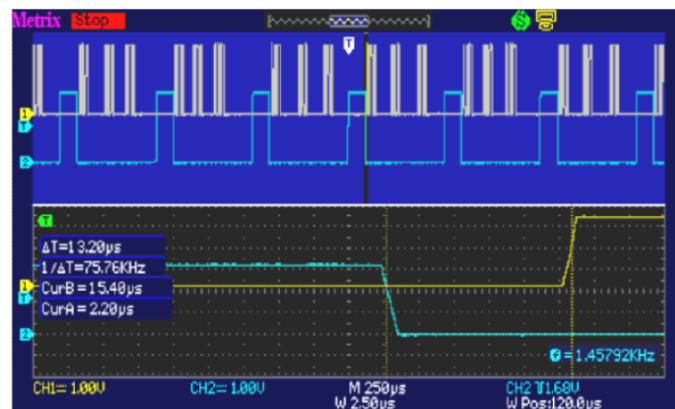

Horizontal displacement of the Zoomed zone by acting on the "Position" encoder:

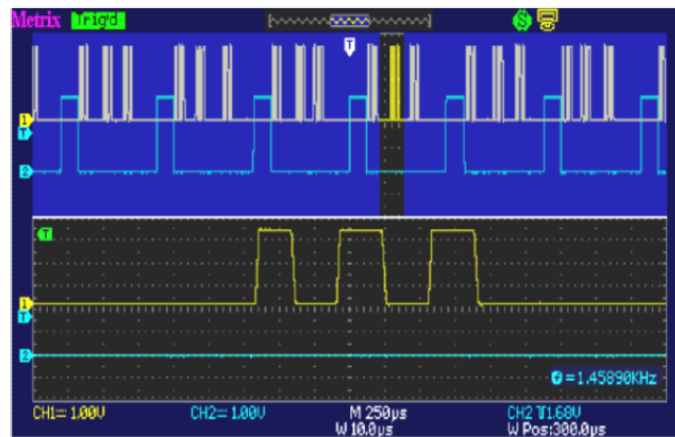

5. DATA FRAME-FAULT

Demo:	with:	<input checked="" type="checkbox"/> DOX2025	<input checked="" type="checkbox"/> DOX2040	<input checked="" type="checkbox"/> DOX2100	<input checked="" type="checkbox"/> DOX2xxxB
Test Signal	n°5 : Data frame-Fault				
Nature	2 signals representing a communication bus with «clock» and «data»				
Specs	Vpp ≈ 3.4 V - F ≈ 31 kHz (clock) - 30 μs < L+ < 200 μs (data)				
Oscilloscope Settings	25 μs/div. - MAIN = 1 V/div. - AUX ≈ 1 V/div.				
Trigger	 on MAIN				
Modes	Triggered mode preferable - SPO mode, duration ≥ 2 s				
Objectives	Capture and observe a rare event using SPO Triggering on pulse width of the AUX signal				

a) Adjust the oscilloscope so as to display the 2 signals in LongMem mode (time base, sensitivities, triggering source on MAIN).



Attention, with this type of signal, “Autoset” operation may be aleatory.

b) Observe a clock and the data bus using the “LongMem” function and the horizontal “Zoom”.

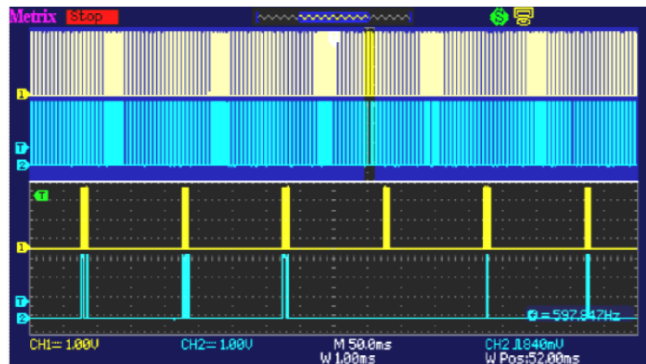

The proposed signal is representative of a communication bus with “data - 8 bits” and a clock.

This communication setup is found in particular with the protocols of serial links such as the I2C bus, USB bus, CAN bus, Ethernet communication, etc.

The first utility of the operating mode is to detect and study faults in signals, without knowing their nature in advance, and therefore without having to set specific triggering conditions, for example.

In our example, we have frames approximately 3 ms apart and 1 frame in 120, or one frame every 360 ms, with the data at zero.

In STOP, using the horizontal zoom (x 50) and choosing the position of the zoomed window, we can observe and analyse this frame and the one just before it and the one just after it.

Then, with the x 1000 zoom factor, we observe the 6 clock pulses of the frame of zeros.



Attention ! the x 1000 zoom factor is available only in the «LongMem» mode, which is available only on the DOX2040 and the DOX2100, on the DOX2025 or on the DOX2040-DOX2100 in Mem.depth mode = “Normal”, the representation of the signal with the x 1000 Zoom factor will be wrong.

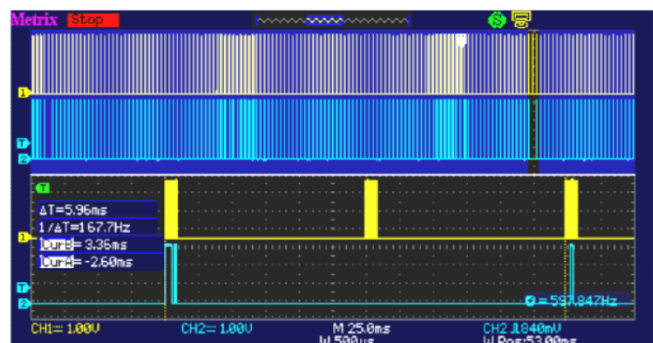
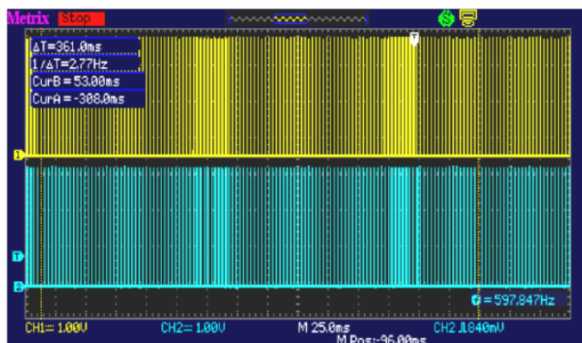

Zoom by 1000 in "LongMem" mode:

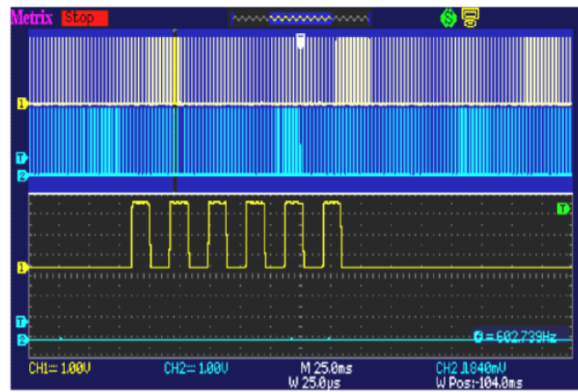

Zoom by 1000 in Memory Depth "Normal":

The representation is wrong: the train of 6 pulses is represented by a single pulse ; the horizontal resolution is insufficient. This is because the sampling rate in Normal Memory Depth is 25KSPS, while it is 1MSPS in LongMem Memory Depth.

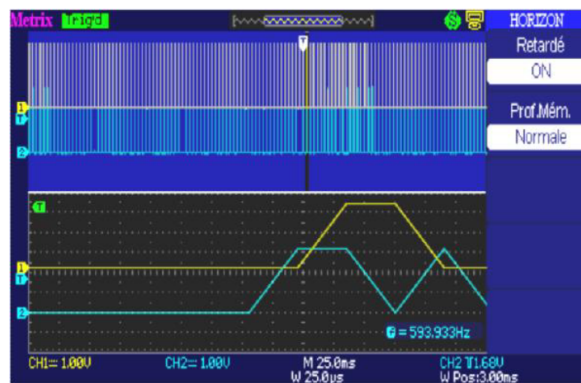

6. AMPLITUDE-MODULATED SINE WAVE

Demo:	with:	<input checked="" type="checkbox"/> DOX2025	<input checked="" type="checkbox"/> DOX2040	<input checked="" type="checkbox"/> DOX2100	<input checked="" type="checkbox"/> DOX2xxxB
Test Signal	n°6 : Amplitude-modulated sine wave				
Nature	1 amplitude-modulated sinusoidal signal				
Specs	1.3 V < Vpp < 3.3 V - F ≈ 1.3 kHz				
Oscilloscope Settings	100 μs/div. - MAIN = 500 mV/div.				
Trigger	on MAIN, 50 % of Vpp				
Modes	Triggered mode preferable-«Delayed» Mode				
Objectives	Display a fast-changing signal (e.g., modulation) Automatic «difference from reference» measurements				

Using the Delayed mode and the automatic peak amplitude measurement, we can observe the global shape of the signal and a zoomed zone. The measured amplitude (Vpp) of the signal in the zoomed zone is displayed on the right side of the screen. By shifting the zoom window using the “Horizontal position” button, we can determine the variation of the amplitude of the AM signal vs time.

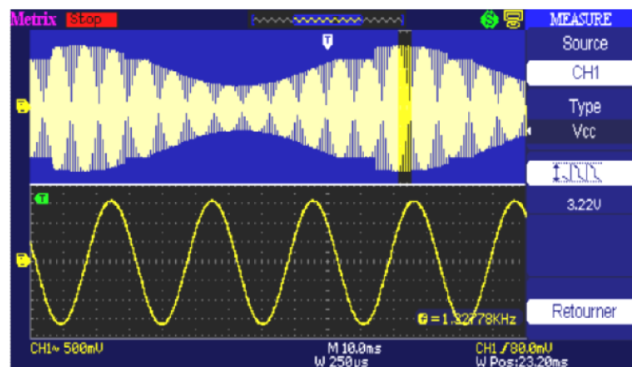

Adjust the oscilloscope so as to display the signals correctly (possible using “Autoset” function).

Persistence «Off»

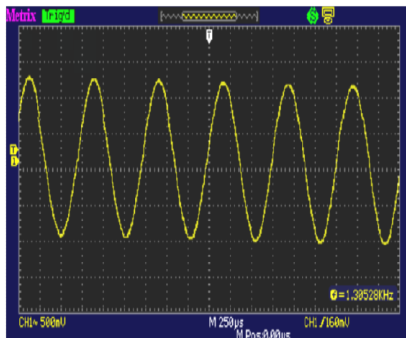

Persistence Infinite

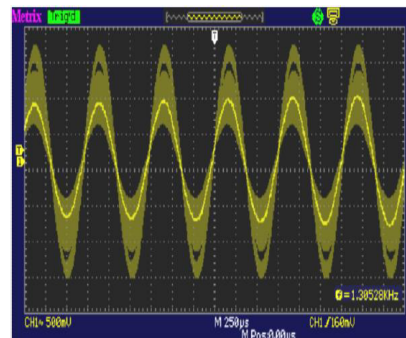

Difference from reference

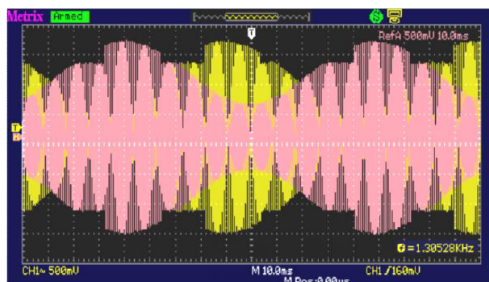

We can press the “REF” key to record the signal on one of the 2 channels as reference, then validate this reference by “On” and observe the variations of the real-time signal of the channel with respect to the frozen reference.

7. SQUARE WAVE-RISE TIME

Demo:	with:	<input checked="" type="checkbox"/> DOX2025	<input checked="" type="checkbox"/> DOX2040	<input checked="" type="checkbox"/> DOX2100	<input checked="" type="checkbox"/> DOX2xxxB
Test Signal	n°7 : Square wave-Rise time				
Nature	1 square wave, duty cycle 50 %				
Specs	$V_{pp} \approx 3.4 \text{ V} - F \approx 10 \text{ kHz} - T_m \approx 800 \text{ ns}$				
Oscilloscope Settings	50 ns to 200 $\mu\text{s}/\text{div.}$ - MAIN = 500 mV/div.				
Trigger	 on MAIN, 50 % of Vpp				
Modes	Triggered mode preferable				
Objectives	Using automatic measurements (F, P, Tr, Tm, Vpp, Vrms, etc.) Activation of a particular measurement				

a) Adjust the oscilloscope so as to display the signal correctly (possible using the "Autoset" function), then validate the 23 automatic measurements available.

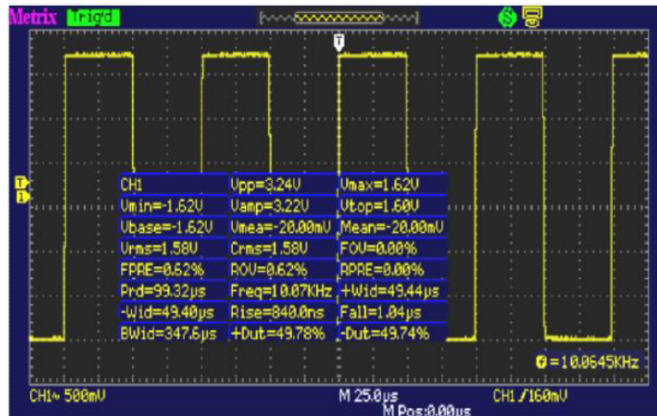

b) Rise Time measurement

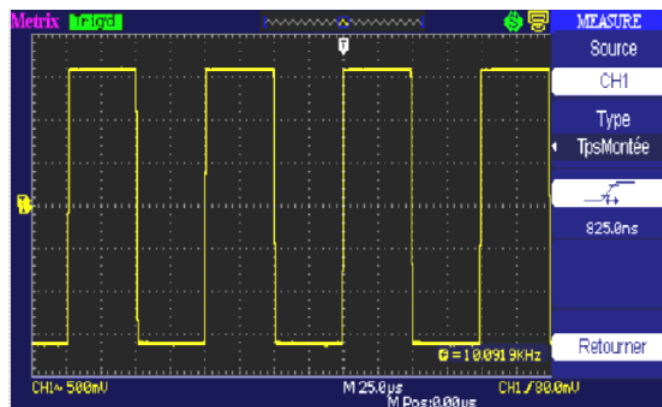

8. SQUARE WAVE - LOW LEVEL - NOISY

Demo:	with:	<input checked="" type="checkbox"/> DOX2025	<input checked="" type="checkbox"/> DOX2040	<input checked="" type="checkbox"/> DOX2100	<input checked="" type="checkbox"/> DOX2xxxB
Test Signal	n°8 : Square wave, low level, noisy				
Nature	1 square wave of very low amplitude and very noisy				
Specs	5 mV < Vpp < 30 mV (depending on filtering) - F ≈ 1 kHz				
Oscilloscope Settings	200 or 500 μs/div. - MAIN = 2.5 or 5 mV/div.				
Trigger	 on MAIN, 50 % of Vpp				
Modes	nothing at first, then 100 kHz low-pass filtering				
Objectives	Triggering and display for a noisy signal Using the Digital filters				

a) Adjust the oscilloscope so as to display the signal approximately.



Attention, with this type of signal, "Autoset" operation may be aleatory.

The noisy signal is of low amplitude.

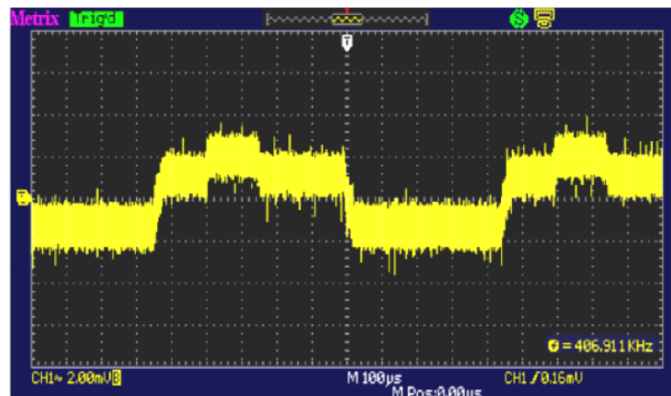

b) The use of a 100 kHz digital low-pass filter makes it possible to analyse the signal without the noise.

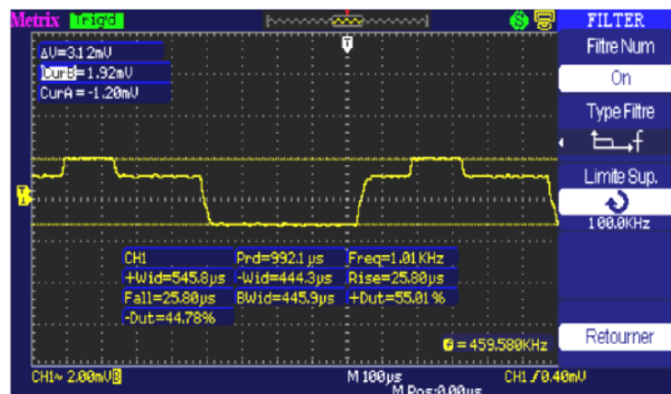

9. COMB OF RAPID PULSES

Demo:	with:	<input checked="" type="checkbox"/> DOX2025	<input checked="" type="checkbox"/> DOX2040	<input checked="" type="checkbox"/> DOX2100	<input checked="" type="checkbox"/> DOX2xxxB
Test Signal	n°9 : Comb of rapid pulses				
Nature	Comb of 6 very brief pulses, with a low repetition rate				
Specs	$V_{pp} \approx 2\text{ V}$ (depending on whether $50\ \Omega$ load or not) - $F \approx 8\text{ kHz}$				
Oscilloscope Settings	25 $\mu\text{s}/\text{div.}$, then 10 ns/div. - MAIN = 500 mV/div.				
Trigger	 on MAIN, 50 % of V_{pp}				
Modes	«LongMem», «Delayed», «ETS»				
Objectives	Utility of the ETS for an accurate and precise representation of signals «Delayed» and «LongMem» mode				

a) Adjust the oscilloscope so as to display the pulse trains and a zoomed train of 6 pulses.



Attention, with this type of signal, "Autoset" operation is in principle impossible.

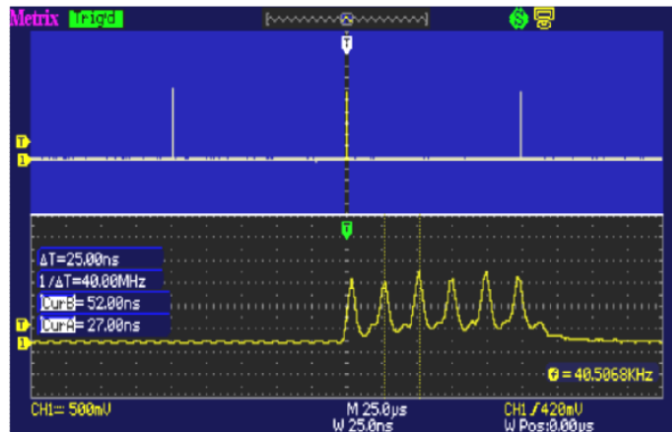

Because of the very brief duration of the pulse (25 ns) compared to their repetition interval ($\approx 125\ \mu\text{s}$), we need a ratio of 1000 between the main time base and the "Delayed" time base.

b) We can also observe the train of 6 pulses in detail in the ETS mode with a 10 ns/div. time base.

The example below presents a train of 6 pulses having a duration $< 10\text{ ns}$ with a rise time $< 4\text{ ns}$.

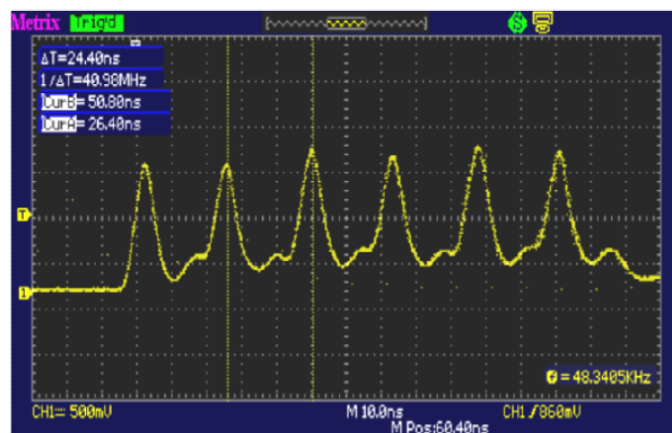

10. DIGITAL FRAME + FAULT

Demo:	with:	<input checked="" type="checkbox"/> DOX2025	<input checked="" type="checkbox"/> DOX2040	<input checked="" type="checkbox"/> DOX2100	<input checked="" type="checkbox"/> DOX2xxxB
Test Signal	n°10 : Digital frame + Fault				
Nature	Digital frame with a recurrent fault				
Specs	F square wave \approx 5 MHz, $V_{pp} \approx$ 1.8 V - L+ fault \approx 7 ns				
Oscilloscope Settings	25 or 50 ns/div., then 250 ns/div. - MAIN = 500 mV/div. DC coupling				
Trigger	 DC coupling on MAIN, level \approx 250 mV				
Modes	Select «Repetitive Signal» (Horiz menu)				
Objectives	Using triggering on pulse width Using the LongMem and Delayed mode				

a) Display the signal (possible using the “Autoset” key), then set the parameters as indicated below. It can be seen that the display is not stable.

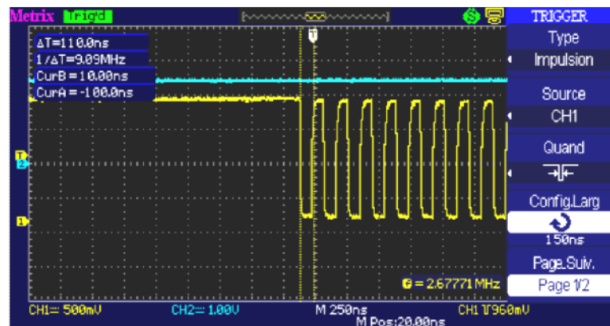

Set the triggering to pulse width < 20 ns and adjust the triggering level to close to the low level of the pulse in order to trigger on the fault.

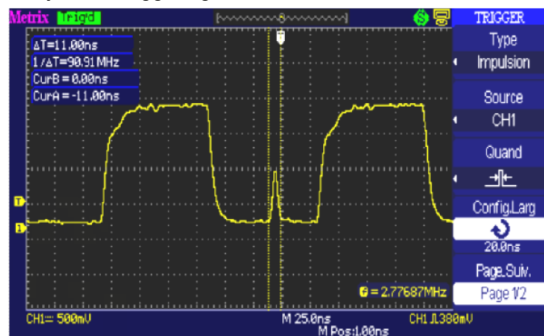

Use the Delayed and LongMem mode in order to be able to analyse the fault and the digital frame in detail.

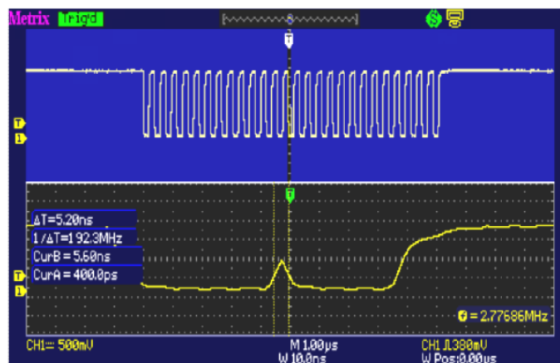

11. FRAME + RARE PULSE

Demo:	with:	<input checked="" type="checkbox"/> DOX2025	<input checked="" type="checkbox"/> DOX2040	<input checked="" type="checkbox"/> DOX2100	<input checked="" type="checkbox"/> DOX2xxxB
Test Signal	n°11 : Frame + Rare pulse				
Nature	Digital clock signal with a fault				
Specs	F clock \approx 5 MHz, Vpp \approx 3.3 V				
Oscilloscope Settings	100 ns/div., then 25 ns/div. - MAIN = 500 mV/div. DC coupling				
Trigger	 DC coupling on MAIN, level \approx 1.8 V				
Modes	Triggered mode preferable - SPO mode, duration 1 or 2 s				
Objectives	Capture and display of a rare fault in SPO mode Triggering possible on pulse width < 20 ns, after SPO analysis				

a) Adjust the oscilloscope so as to display the signal approximately (possible using the "Autoset" mode), then set the parameters as indicated opposite.

b) The signal displayed represents a digital clock at 100 ns.
 By paying attention, it may be possible to spot a certain instability of some edges of the signal.

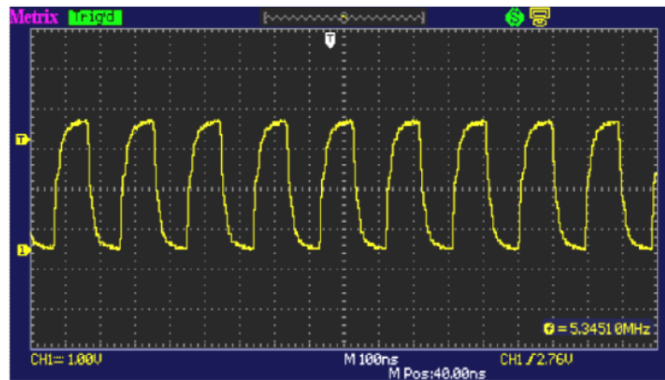

c) Enter Delayed mode with 10 ns/div. for the delayed time base.

The fault is rather rare, since it affects only one clock pulse in 1000.
 It is a brief pulse, lasting less than 10 ns, on the negative-going edge of the clock pulse.

We are going to use triggering on pulse width < 20 ns by placing the triggering level on the top part of the clock pulse to achieve stable triggering on the fault, then use the Delayed and LongMem mode to display the clock signal and the fault.

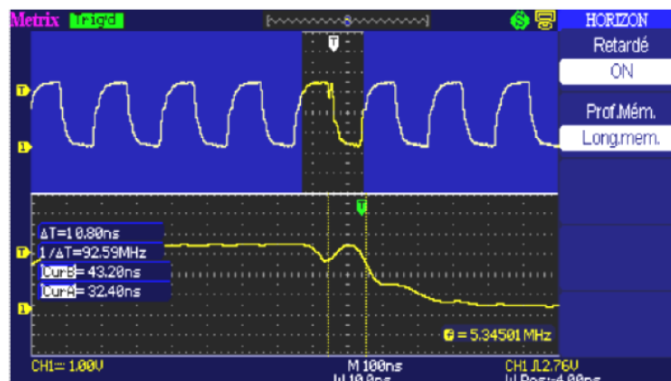

12. RECORDER-5 SIGNALS

Demo:	with:	<input checked="" type="checkbox"/> DOX2025	<input checked="" type="checkbox"/> DOX2040	<input checked="" type="checkbox"/> DOX2100	<input checked="" type="checkbox"/> DOX2xxxB
Test Signal	n°13 : Recorder-5 signals				
Nature	Tracking of 5 slow signals having varied shapes and characteristics				
Specs	Duration of each signal ≈ 1 s, amplitude $1.5 \text{ V} < V_{pp} < 3.5 \text{ V}$				
Oscilloscope Settings	Duration-2 s scale - $40 \mu\text{s}$ - MAIN = 500 mV/div. DC coupling				
Trigger	None at first, then threshold(s) on MAIN, level according to signal				
Modes	«Source/Level» triggering				
Objectives	<p>Elementary presentation of the «Scan» mode for the $< 50 \text{ ms/div.}$ time base</p> <p>Attention, the Scan and LongMem modes, along with the Scan and Delayed modes, are not compatible.</p> <p>Attention, in Scan mode, for the «Level» to be active, the triggering must be in «Normal» mode when the Type of Trigger is on «Front».</p>				

Observe in Scan mode the signals delivered by the HX0074 demonstrator.

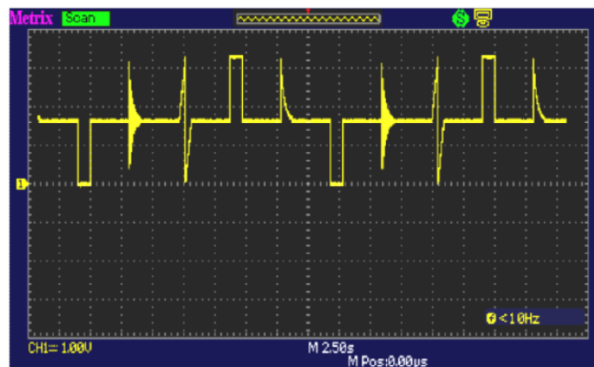

Using triggering on pulse width and acting on the position of the level, it will be possible to trigger on each of the 5 slow signals.

By placing the triggering level close to zero and programming the pulse width, it is possible to synchronise to the damped sine wave, the low pulse, and the low ramp.

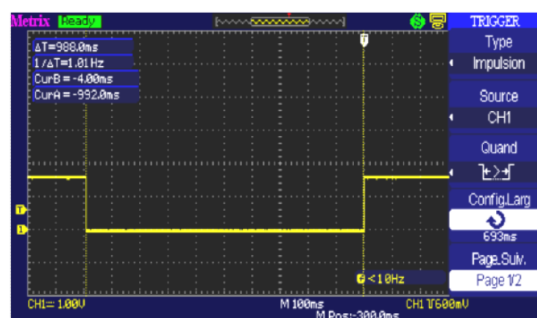
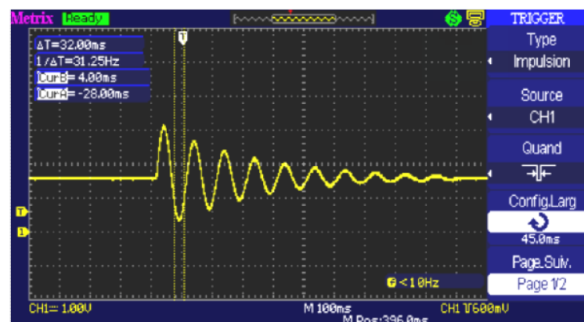

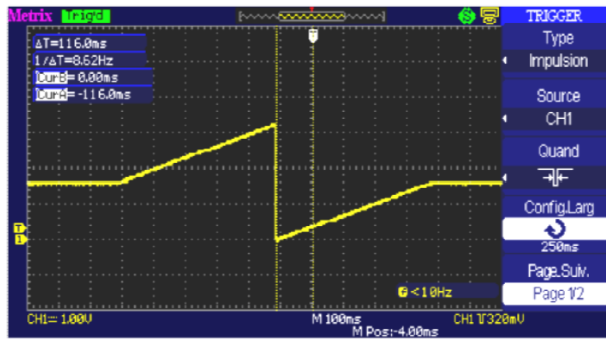

By placing the triggering level above the mean level of the signal and acting on the width of the positive pulse, it is possible to synchronise to the high pulse.

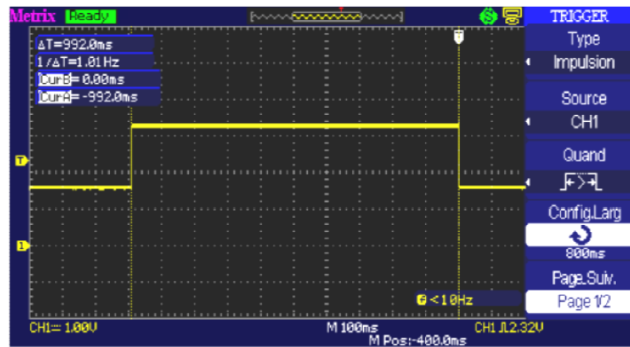

13. HEART RECORDER

Demo:	with:	<input checked="" type="checkbox"/> DOX2025	<input checked="" type="checkbox"/> DOX2040	<input checked="" type="checkbox"/> DOX2100	<input checked="" type="checkbox"/> DOX2xxxB
Test Signal	n°13 : Heart recorder				
Nature	Slow «heartbeat» type signal and increasing/decreasing VDC				
Specs	Frequency of the signal ≈ 0.5 s, amplitude ≈ 3.2 V (heartbeat)				
Oscilloscope Settings	Duration 10 s then 2 s - MAIN and AUX = 500 mV/div. DC coupling				
Trigger	None at first, then EXT thresholds on MAIN, levels 1 V and 2.6 V				
Modes	«Source/Level» triggering				
Objective	Entry of slow signals, «Normal» trigger mode				

a) Entry of signal no. 13 by "Front" type triggering, source CH2, "Normal" trigger mode.

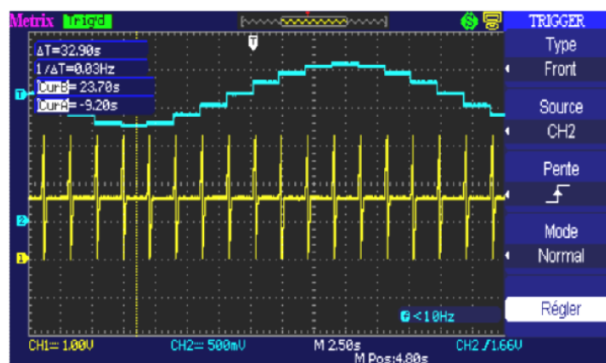

b) Display of Signal no. 13 by Zooming in "STOP", serves to observe one period of signal CH2 and signal CH1 in detail.

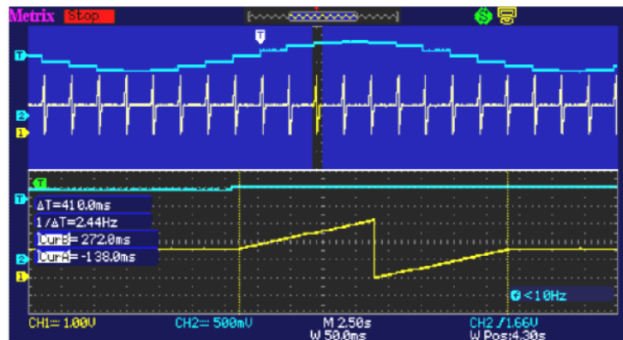

c) The measurements can be made using the manual cursors, but it is also possible to display the 23 automatic measurements made on the desired channel simultaneously.

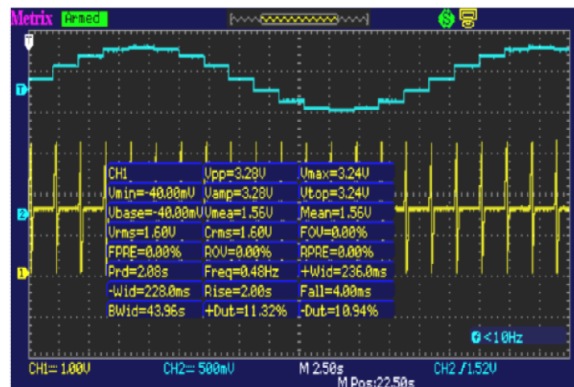

14. HARMONICS

Demo:	with:	<input checked="" type="checkbox"/> DOX2025	<input checked="" type="checkbox"/> DOX2040	<input checked="" type="checkbox"/> DOX2100	<input checked="" type="checkbox"/> DOX2xxxB
Test Signal	n°14 : Harmonics				
Nature	2 signals, one square, the other triangular				
Specs	Frequency of the signal ≈ 50 Hz, $V_{pp} \approx 3.2$ V (triangular), $V_{pp} \approx 3.4$ V (square)				
Oscilloscope Settings	5 ms/div. - MAIN and AUX = 1 V/div. DC coupling				
Trigger	 DC coupling on MAIN, 50 % of V_{pp} for example				
Modes	«Oscilloscope» mode, y(t)				
Objective	Display of a square and a triangular signal				

a) Adjust the oscilloscope so as to display the signal approximately in accordance with the first figure (possible using the “Autoset” mode), then set the parameters as indicated above.

Then select the “FFT” Mathematical function.

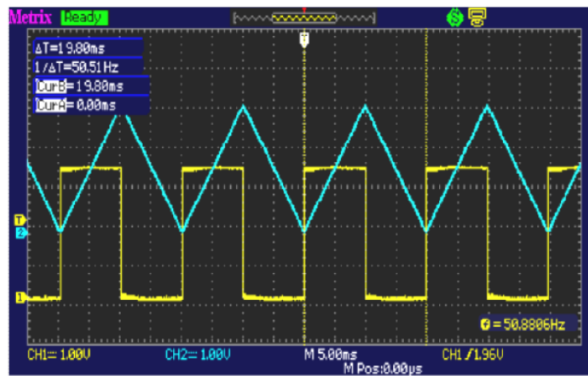

15. DISTORTION

Demo:	with:	<input checked="" type="checkbox"/> DOX2025	<input checked="" type="checkbox"/> DOX2040	<input checked="" type="checkbox"/> DOX2100	<input checked="" type="checkbox"/> DOX2xxxB
Test Signal	n°15 : Distortion				
Nature	1 pseudo-sinusoidal signal containing harmonic distortion				
Specs	Frequency of the signal \approx 50 Hz, $V_{pp} \approx$ 3.2 V				
Oscilloscope Settings	2.5 ms/div. - MAIN = 500 mV/div. DC coupling imperative				
Trigger	 DC coupling on MAIN, level 50 % of V_{pp} , for example				
Modes	«Oscilloscope» mode				
Objective	Display of a frequency-modulated 50 Hz sine wave with components				

a) Adjust the oscilloscope so as to display the signal by pressing the "Autoset" key, then set the parameters as indicated above.

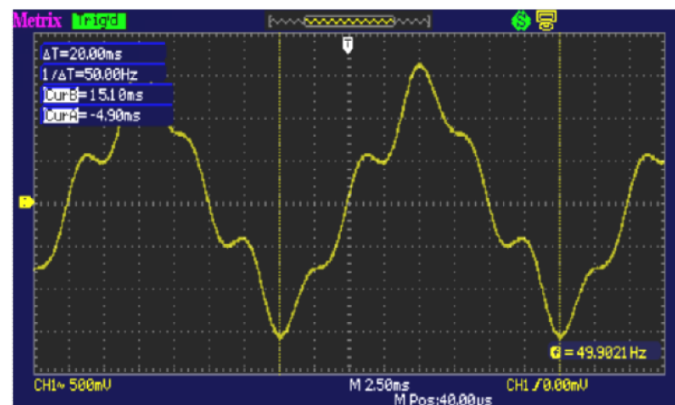
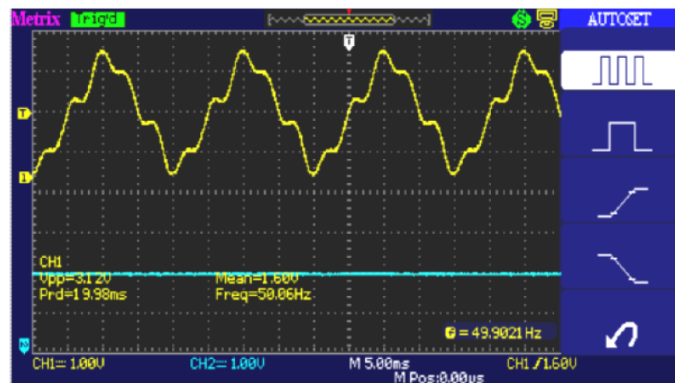

- ✓ Sine wave having an amplitude 0.3 V (10 %) ; frequency 150 Hz (order 3) ; phase shift: π (180°)
- ✓ Sine wave having an amplitude 0.6 V (18 %) ; frequency 250 Hz (order 5) ; phase shift: $\pi/2$ (90°)

II. DEMONSTRATION GX1025 WITH DOX2000

1. USING THE GX1025 GENERATOR TO DEMONSTRATE THE ADVANTAGES OF THE “LONGMEM” MEMORY DEPTH AND OF THE DIGITAL FILTERS

1.1. INFLUENCE OF MEMORY DEPTH (LONGMEM OR NORMAL) ON THE SAMPLING INTERVAL:

The sampling rate of the DOX2070B-DOX2100B oscilloscopes for the time base position **M = 250 μ s/div**- for example- is **50 MSPS** with a memory Depth = «**LongMem**» and **2.5 MSPS**. If the Memory Depth = «**Normal**», the minimum observable in DOTs will therefore be, in this case, 20 ns when «**LongMem**» is active and 400 ns in «**Normal**» mode.

To see the effect of the «**LongMem**» function during a fine analysis of a signal, we are going to observe, in «**Delayed**» mode, a sinusoidal signal having a frequency of **10 MHz** in DOTs display mode and **Vectors** with a main time base of **M = 250 μ s/div**. and a Delayed time base of **W = 25 ns/div**. (there is a ratio of **10 000** between the **M** and **W** time bases).

When the LongMem function is activated, the 10 MHz sinusoidal signal is perfectly observable with the Delayed time base and a Zoom factor of 10000, because the 20 ns sampling interval is shorter than the 50 ns half-period of the sinusoidal signal.

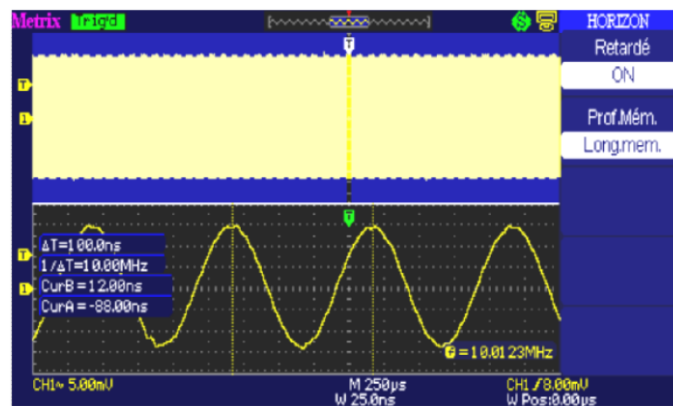

But when the memory depth is “Normal”, the 10 MHz sinusoidal signal is no longer properly reconstituted, because the 400 ns sampling interval is longer than the 100 ns period of the 10 MHz sinusoidal signal:

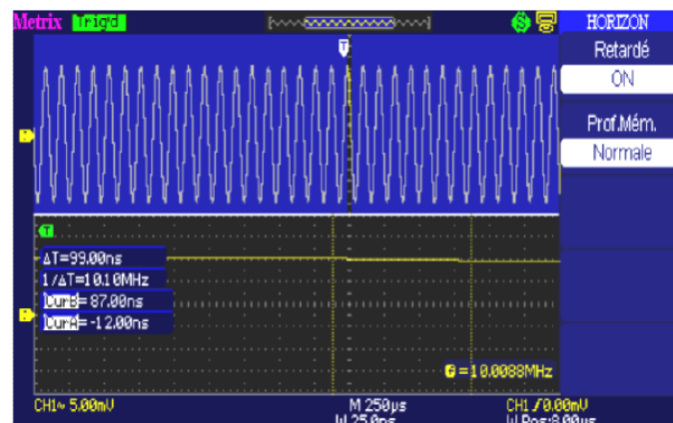

Conclusion : By switching the memory depth from “Normal” to “LongMem”, we can record the same time interval with a recording interval 20 times as fine, making possible a finer analysis of the signal, in “Delayed” mode, for example.

2. USING THE DIGITAL FILTERS

2.1. 2 KHZ SQUARE WAVE WITH A 62 KHZ SINE WAVE SUPERPOSED ON ITS PLATEAUS

a) Display of the 2 kHz square wave with a 62 kHz sine wave superposed on its plateaus:

Remark: the frequencies of the Digital Filters depend on the sampling frequency and therefore on the time base range ($M = 250 \mu\text{s}$), so we recommend observing the details of the signals with the "Delayed" time base ($W = 25 \mu\text{s}$) and a normal memory depth; this does not alter the cut-off frequencies of the filters, which depend on the main time base range, $M = 250 \mu\text{s}$.

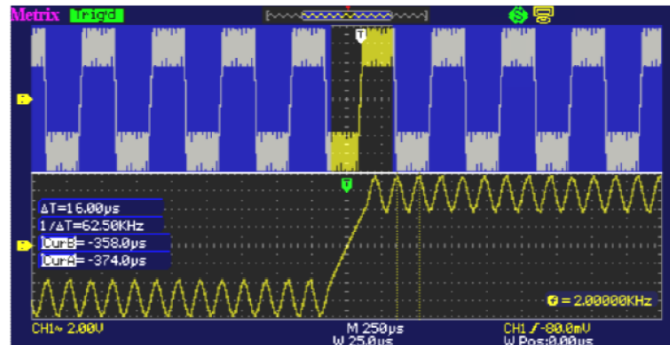

b) A "low-pass" digital filter having a high cut-off frequency of 25 kHz is applied to this signal:

The 62 kHz sinusoidal signal, which is above the high cut-off frequency of the filter, disappears and the edges of the 2 kHz square wave are rounded (see below):

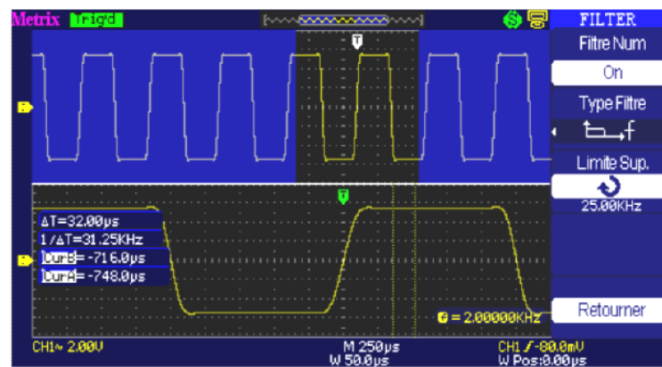

c) A "high-pass" digital filter having a low cut-off frequency of 25 kHz is applied:

The 2 kHz square wave is blocked by the high-pass filter leaving only the 60 kHz sinusoidal signal, which is above the low cut-off frequency of the filter.

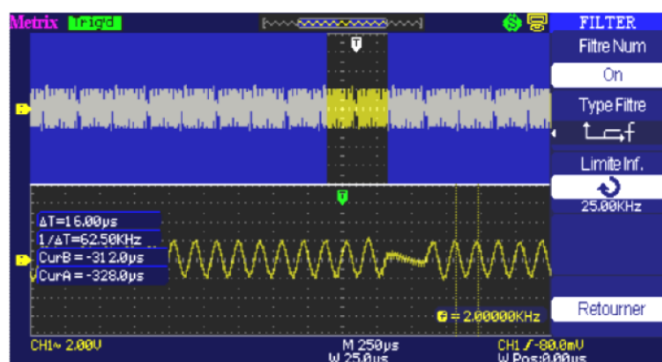

d) A "band-pass" digital filter having a pass band from 12.5 kHz to 100 kHz is applied:

The 2 kHz square wave, which is not in the pass band, is blocked by the filter, leaving only the 60 kHz sinusoidal signal, which is in the pass band.

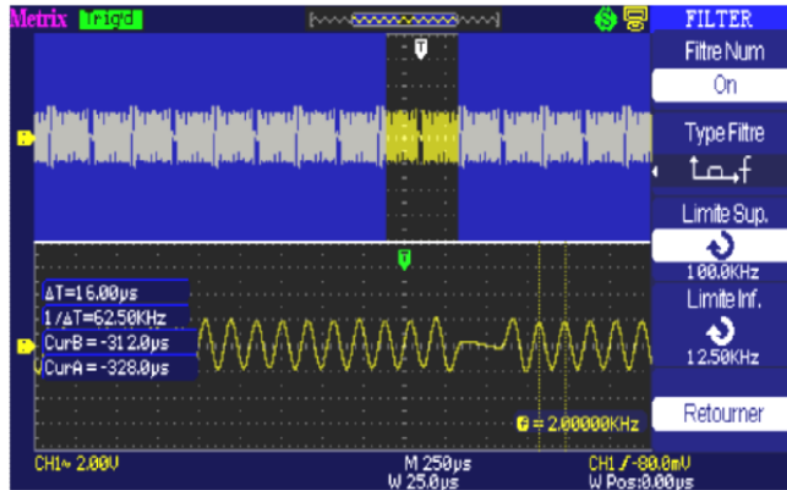

e) A "band-stop" digital filter (25 kHz to 800 kHz) is applied:

The 62 kHz sinusoidal signal is attenuated, while the 2 kHz square wave passes intact.

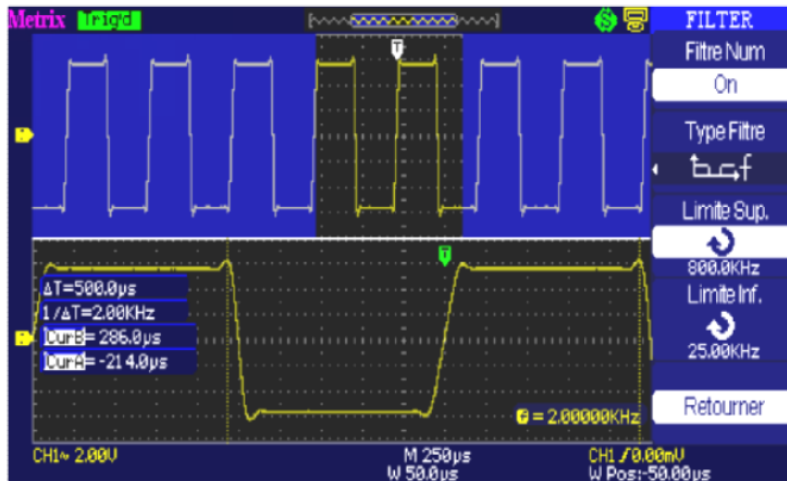

3. SUM OF 2 SINUSOIDAL SIGNALS HAVING FREQUENCIES OF 10 KHZ AND 80 KHZ

3.1. DISPLAY OF THE SUM OF 10 KHZ AND 80 KHZ SINE WAVES

The low frequency (~10 kHz) indicated by the hardware frequency counter is displayed at bottom left of the screen (take care to set the triggering level close to zero).

We use the cursors to measure the high frequency (~76.92 kHz).

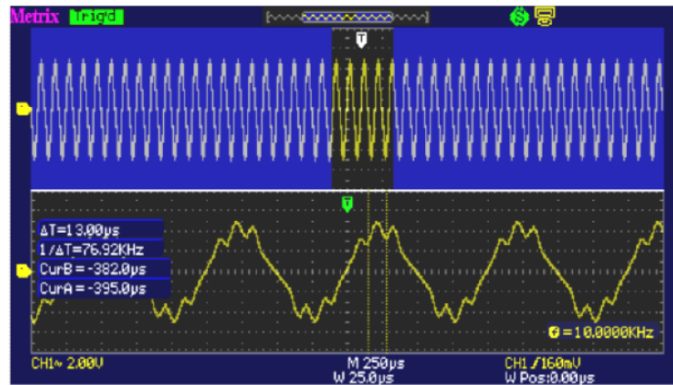

When a “low-pass” digital filter having a cut-off frequency of 37.5 kHz is applied, the 10 kHz sine wave passes but the 80 kHz sine wave is highly attenuated.

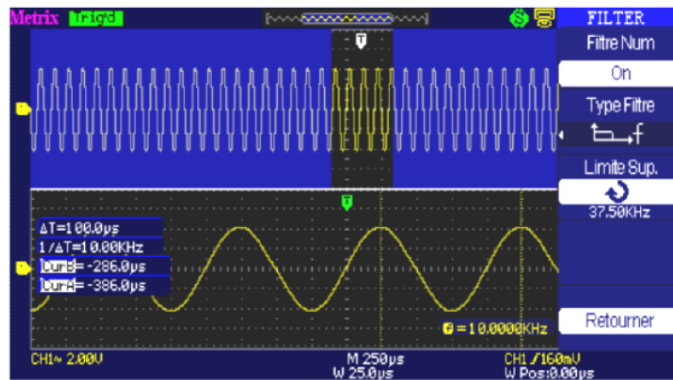

We are now going to observe the effect to the “Low-Pass” filter on the 10 kHz/80 kHz sine wave using the FFT.

Display of the Signal and its FFT with the “Off” digital filter.

The FFT shows the 10 kHz fundamental and the 80 kHz harmonic of the signal.

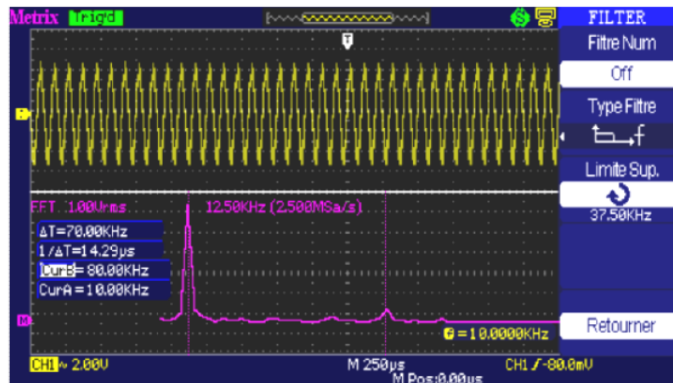

FFT of the signal with the low pass digital filter having a cut-off frequency of 37.5 kHz.

The FFT shows the 10 kHz fundamental but the 80 kHz harmonic has been highly attenuated by the digital filter.

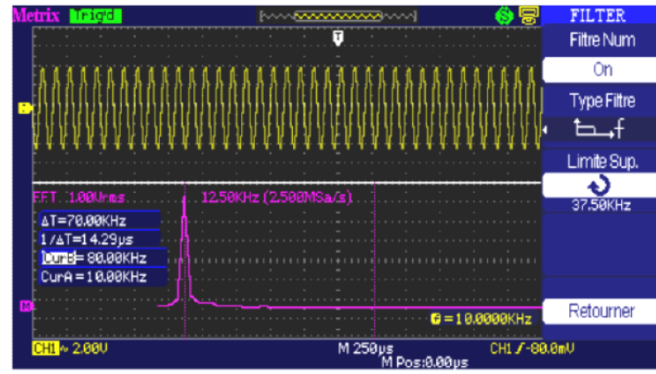

4. PRODUCT OF 2 SINE WAVES HAVING FREQUENCIES OF 100 KHZ AND 800 KHZ

4.1. DISPLAY OF THE PRODUCT SIGNAL WITH DELAYED TIME BASE

We use the cursors to measure the frequency of the product signal, $F = 800$ kHz (Remark: the hardware frequency counter indicates 399.996 kHz because the triggering level is adjusted on the peaks of the product signal);

Configuration of the oscilloscope:

Time base range M = 100 μ s

Memory Depth = Normal

Acquisition : Samples

Display : Vectors

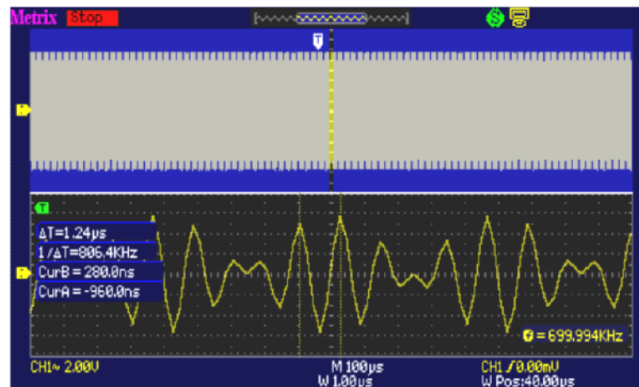

Then the low frequency of the product signal $F = 100$ kHz

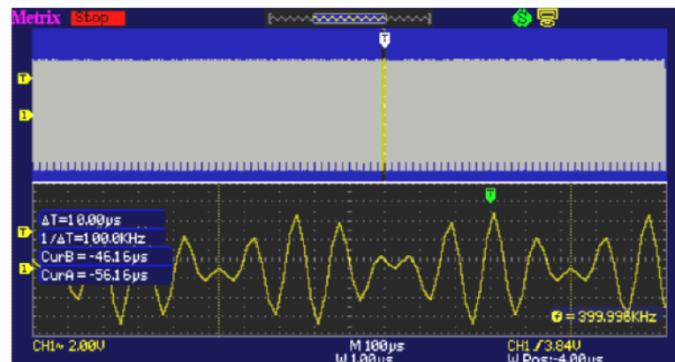

The FFT of the product signal shows spikes at the sum frequency (900 kHz = 800 kHz + 100 kHz) and at the difference frequency (700 kHz = 800 kHz - 100 kHz)

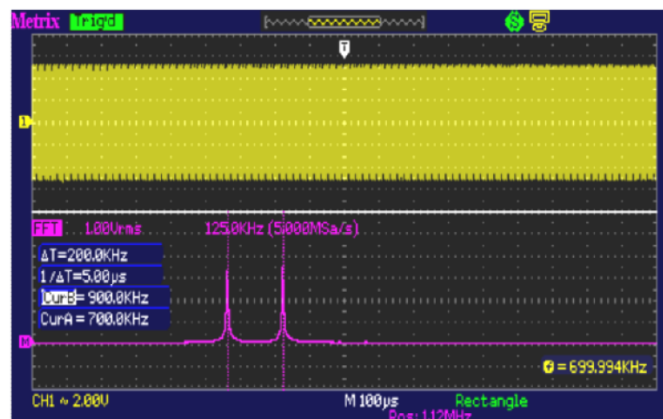

Using a bandpass filter centred on 700 kHz, then on 900 kHz, we are going to be able to isolate these 2 spectral components.

a) A bandpass digital filter (650 kHz 825 kHz) is used to isolate the 700 kHz spectral component.

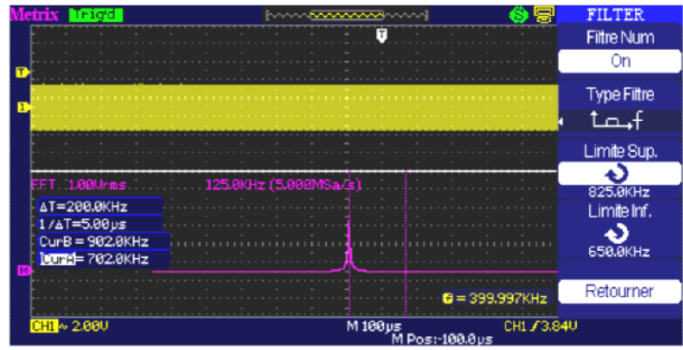

Display of the 700 kHz spectral component with delayed time base.

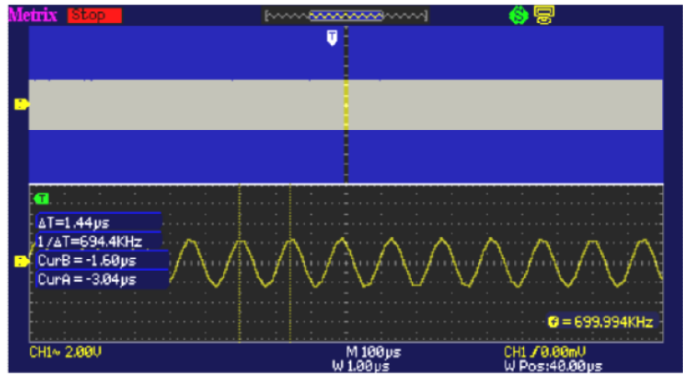

b) A bandpass filter (825 kHz, 1 MHz) is used to isolated the 900 kHz component:

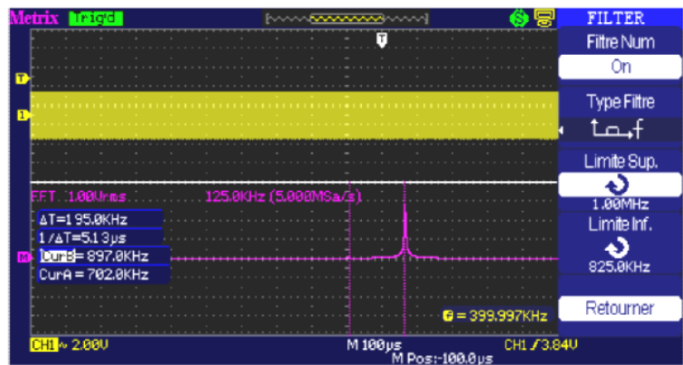

Display of the 900 kHz component with delayed time base:

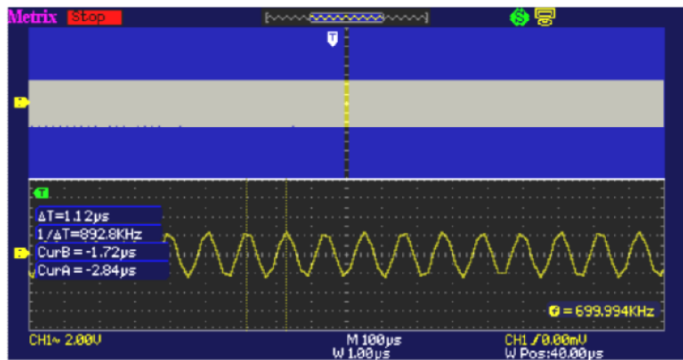

5. PRODUCT OF 2 SINUSOIDAL SIGNALS HAVING FREQUENCIES OF 10 KHZ AND 80 KHZ

5.1. DISPLAY OF THE PRODUCT SIGNAL WITH DELAYED TIME BASE

We use the cursors to measure the frequency of the 80 kHz product signal (remark: the hardware frequency counter indicates 40.0 kHz because the triggering level is adjusted on the peaks of the product signal).

Configuration of the oscilloscope:
 Time base range M = 1.0 ms
 Memory Depth = Normal
 Acquisition : Samples
 Display : Vectors

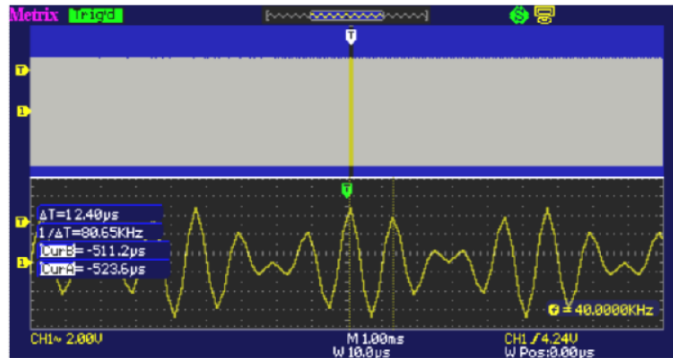

Then the low frequency of the product signal, 10 kHz:

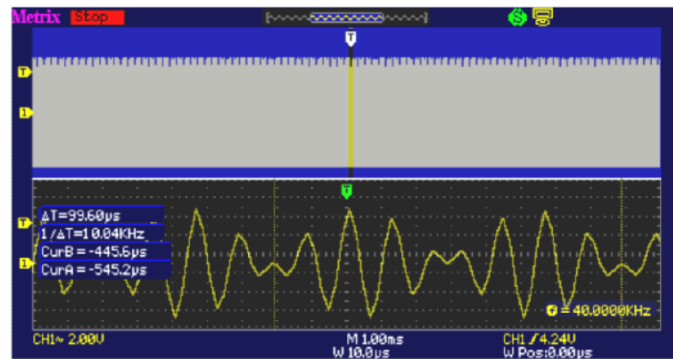

The FFT of the product signal shows two spectral components having the same amplitude, one at the $F = 90$ kHz sum frequency (10 kHz + 80 kHz) and the other at the $F = 70$ kHz difference frequency (80 kHz - 10 kHz).

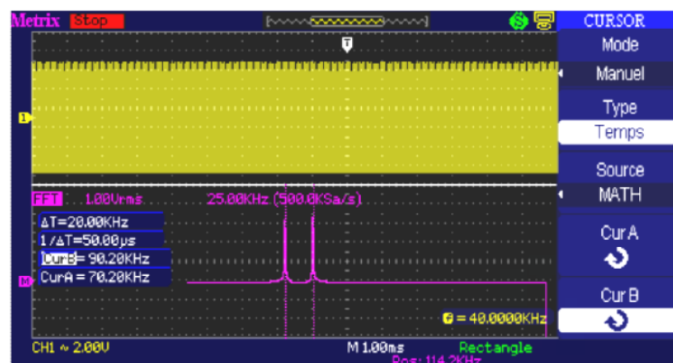

We use a bandpass digital filter (60 kHz 80 kHz) to isolate the 70 kHz spectral spike:

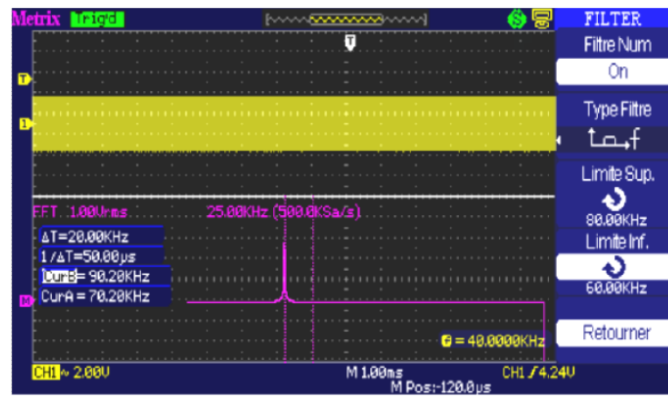

We view the filtered signal and use the cursors to measure its frequency, $F = 70$ kHz and its amplitude = 5.12 V peak to peak:

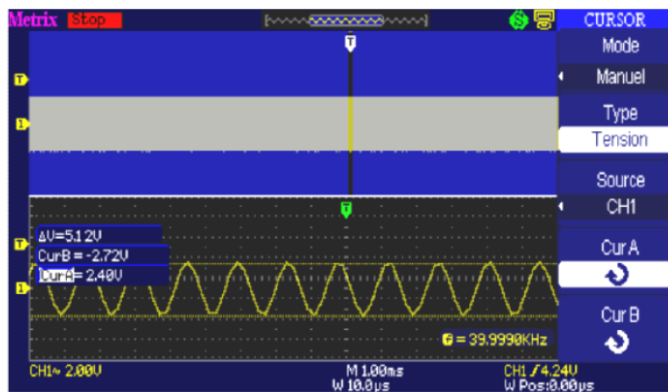
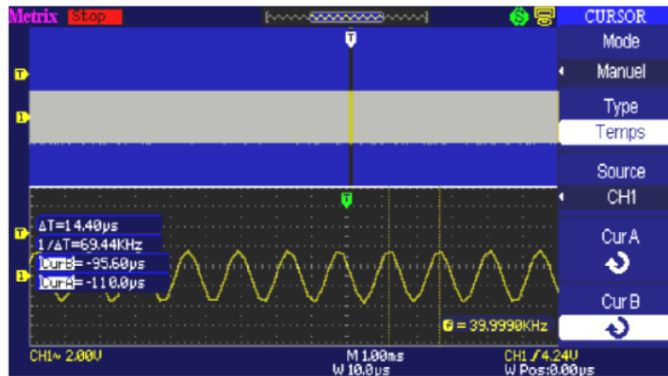

We separate the 90 kHz spectral spike with a bandpass filter (85 kHz - 100 kHz) :

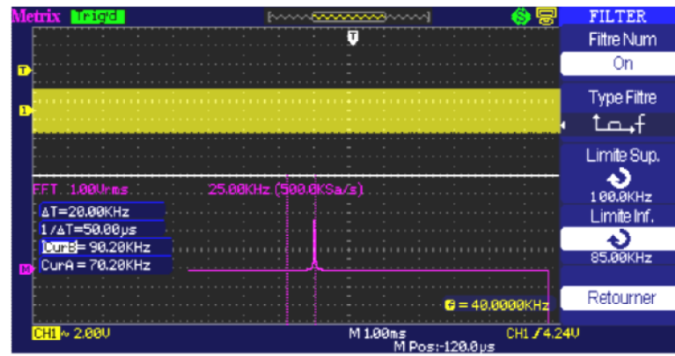

We view the filtered signal and use the cursors to measure its frequency, $F = 90$ kHz, and its amplitude = 5.12 V peak to peak:

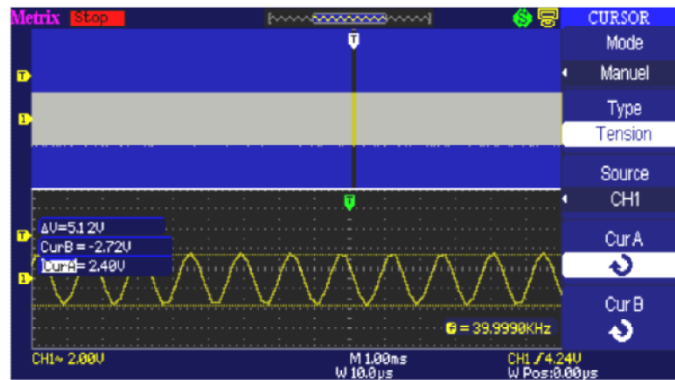
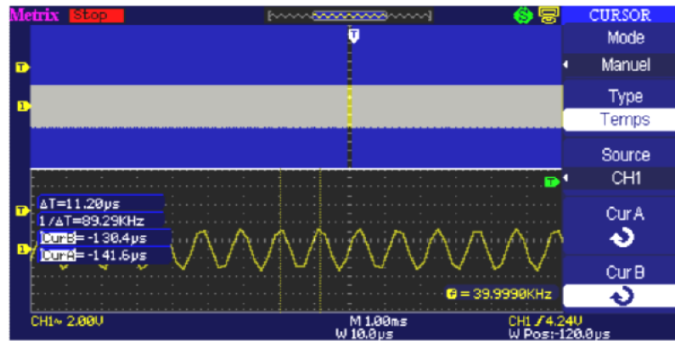

metrix

FRANCE

Chauvin Arnoux

12-16 rue Sarah Bernhardt

92600 Asnières-sur-Seine

Tél : +33 1 44 85 44 85

Fax : +33 1 46 27 73 89

info@chauvin-arnoux.com

www.chauvin-arnoux.com

INTERNATIONAL

Chauvin Arnoux

Tél : +33 1 44 85 44 38

Fax : +33 1 46 27 95 69

Our international contacts

www.chauvin-arnoux.com/contacts

